

UMEC International Corporation

UP1301A SERIES

130 Watt Open Frame Switchers

- ◆ Small Size 3*5*1.2(inches)
- ◆ Universal Input 90 to 264 VAC
- ◆ Low Power Consumption
- ◆ Overvoltage Protection
- ◆ Continuous Short Circuit Protection
- ◆ Over Temperature Protection
- ◆ Active PFC for EN61000-3-2 Class A & D Compliance
- ◆ EMI Meets FCC/CISPR 22 Class B
- ◆ MTBF 500Khrs
- ◆ RoHS Compliant

Green Product
RoHS



SPECIFICATIONS

All specifications are typical at nominal line, full load and 25°C unless otherwise noted.

INPUT SPECIFICATIONS

Input Voltage Range ¹	90-264VAC
Input Frequency	47-63 Hz
Inrush Current	40A max @110Vac Cold Star
.....	80A max @230Vac Cold Star
Line Regulation ²	±1%
Input Current ²	3.3Arms max
Low Power Consumption ³	1.5W max. @ 110Vac
.....	1.5W max. @ 230Vac

GENERAL SPECIFICATIONS

Hold-up Time	20mS typ.
Efficiency	80% typ.
Leakage Current, 12V/24V/48V	1mA max.
15V	0.5mA max.
Over Temperature Protection	Autorecovery
Short Circuit Protection	Continuous
.....	Autorecovery
Overload Protection	110-200% of rated value
Overvoltage Protection (Clamp or Latch type)	
12V	15V typ.
15V	18V typ.
24V	30V typ.
48V	55V typ.
Continuous Output Power:	
Forced Air Cooling with 15CFM/600LFM fan ⁴ ..	130W max
Hi-pot Isolation: Input/ Output	4242 VDC
Weight	330g

ENVIRONMENTAL SPECIFICATIONS

Operating Temperature Range	0°C to 50°C
Temperature Coefficient	±0.02%/°C
Storage Temperature Range	-40°C to +85°C
Humidity, Non-Condensing	0 to 95% RH
EMI	Meets FCC/CISPR 22 Class B Specification
MTBF ⁵	500K hrs

NOTES:

1. Nominal line is 110VAC, 230VAC.
2. Measured from 90 to 264 VAC.
3. No load.
4. See figure 1.
5. Measured with forced air cooling of 15CFM/600LFM fan.



UMEC International Corporation
2539 West 237th Street, Suite A
Torrance, California 90505 USA

www.umecintl.com
Tel: 310-326-7072
Fax: 310-326-7058

UMEC International Corporation

OUTPUT SPECIFICATION

Model Number	Output ¹ Voltage (Volts)	Output Current (Amps)		Ripple ² P-P	Load Regulation ³
		Min.	Rated		
UP1301A-12	12	0.0	10.8	120 mV	±1%
UP1301A-15	15	0.0	8.7	150 mV	±1%
UP1301A-24	24	0.0	5.4	240 mV	±1%
UP1301A-48	48	0.0	2.7	480 mV	±1%

NOTES:

1. The output voltage is set to ±3%, with the output at rated load and output sense will compensate for up to 1V drop between converter and load. If sense is not being used, the +sense should be connected to its corresponding to +output and likewise the -sense should be connected to its corresponding -output.
2. Add a 0.1uf ceramic capacitor and a 10uf E.L. capacitor to the output cable. Peak to peak and RMS metering equipment shall have a 20MHz response with probes and cables maintaining frequency response from 200Hz to 100MHz band width. Output ripple and spikes are measured directly at the output terminals of the power supply without the use of the probe ground clip.
3. Load regulation is measured at 110VAC or 230VAC input, Load regulation is defined by changing ±40% of measured Output load from 60% rated load.
4. Replace input line fuse with same type rating. Recommended 4A / 250VAC time lag fuse.
5. Mounting hole MH1, MH2, MH4 should be grounded for EMI purpose.
6. UP1301A series will be assembled as Class I equipment, and the secondary of end product must be connected to earth for safety requirement.

PHYSICAL SPECIFICATIONS

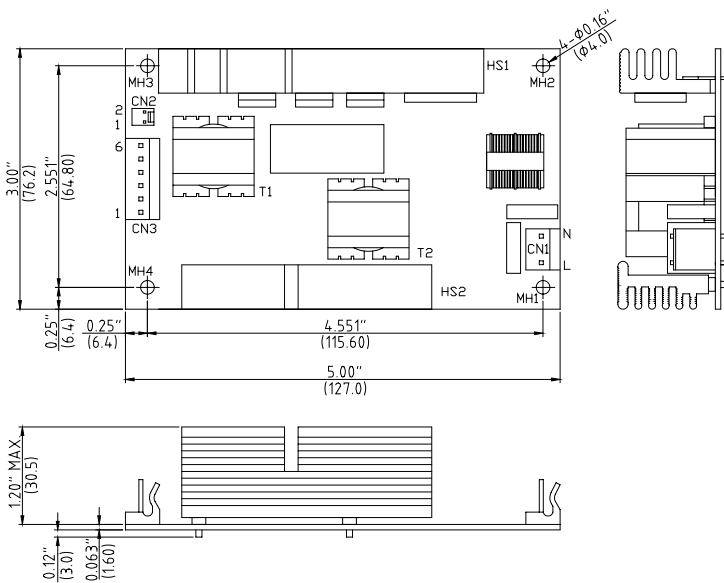

NOTES:

1. All dimensions are in inches (mm).
2. Tolerance .XX=±0.05", .XXX=±0.020"

CN1 input connector Molex 5277-02A or equivalent	
Pin	Input voltage
L&N	90-264VAC

CN2 output connector Molex 5045-02A or equivalent	
Pin	UP1301A-XX
1	+Sense
2	-Sense

CN3 output connector Molex pin 5273-06A or equivalent	
Model	
Pin	UP1301A-XX
1	Vo
2	
3	
4	Common
5	
6	



UMEC International Corporation
2539 West 237th Street, Suite A
Torrance, California 90505 USA

www.umecintl.com
Tel: 310-326-7072
Fax: 310-326-7058

UMEC International Corporation

AD-UP1301A-XX Single Output Connection Diagram

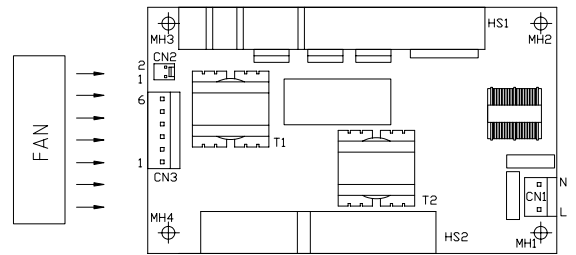
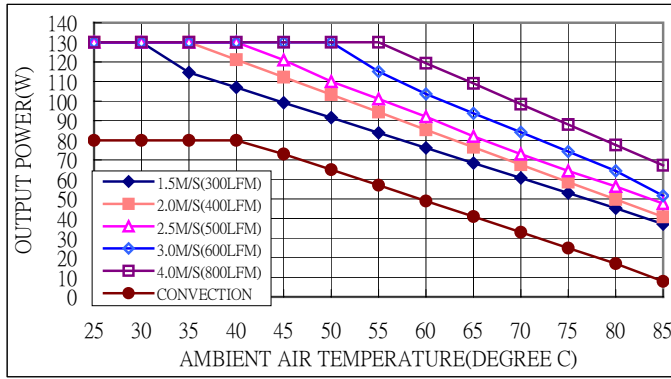
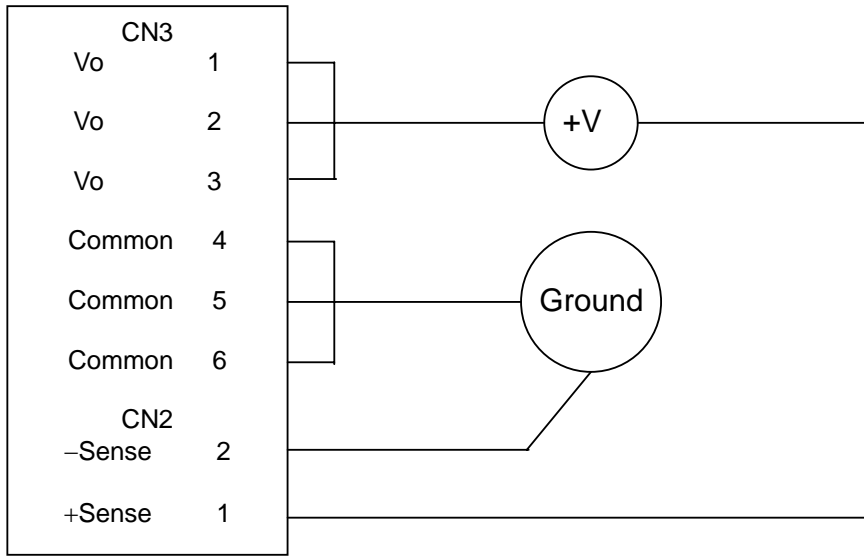

Figure 1: Output power vs Temperature with Forced Air Cooling with Airflow Direction from Output to Input Vin=90Vac

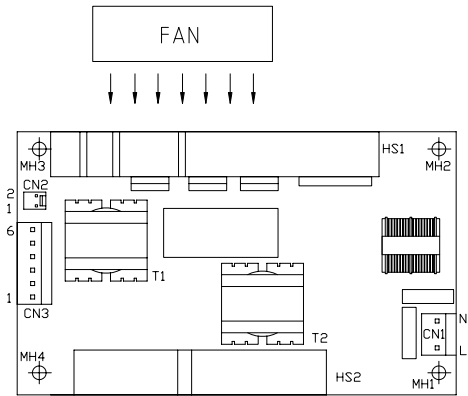
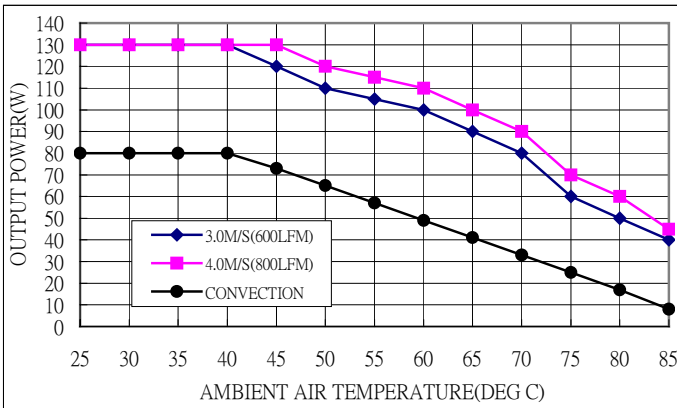

Figure 2: Out power vs Temperature with Forced Air Cooling with Airflow Direction from HS1 to HS2 Vin=90Vac



UMEC International Corporation
 2539 West 237th Street, Suite A
 Torrance, California 90505 USA

www.umecintl.com
 Tel: 310-326-7072
 Fax: 310-326-7058

UMEC International Corporation

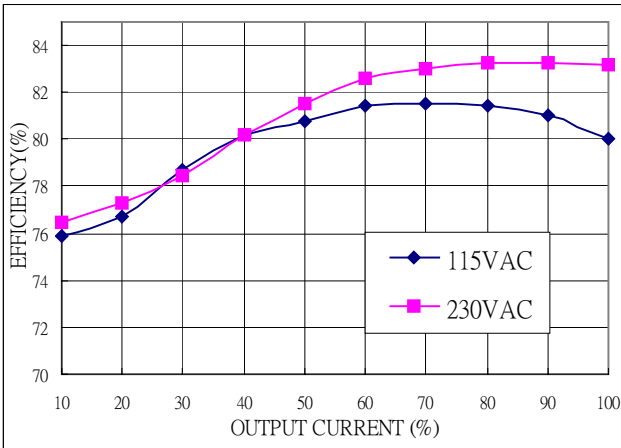

Figure 3: Efficiency vs Load (Vo=12V)

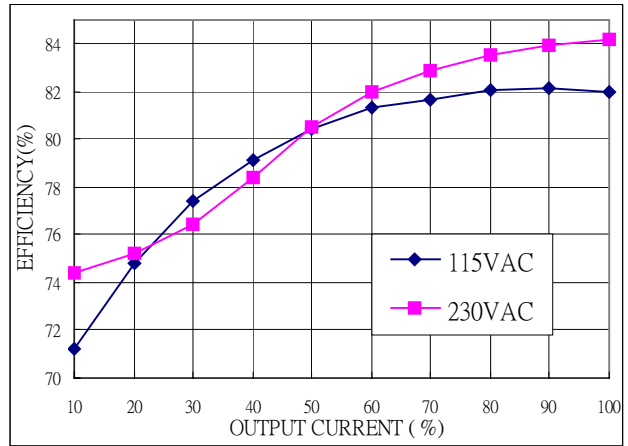

Figure 4: Efficiency vs Load (Vo=15V)

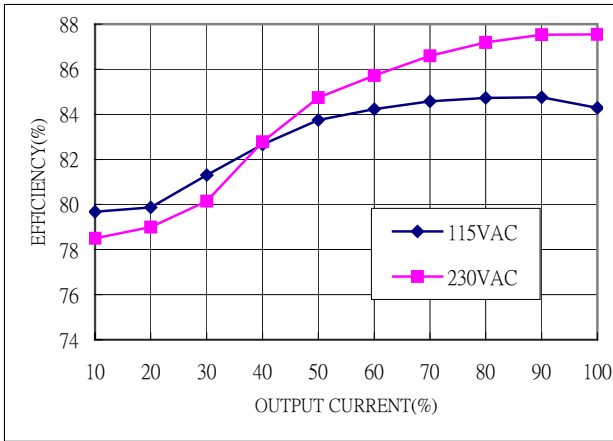

Figure 5: Efficiency vs Load (Vo=24V)

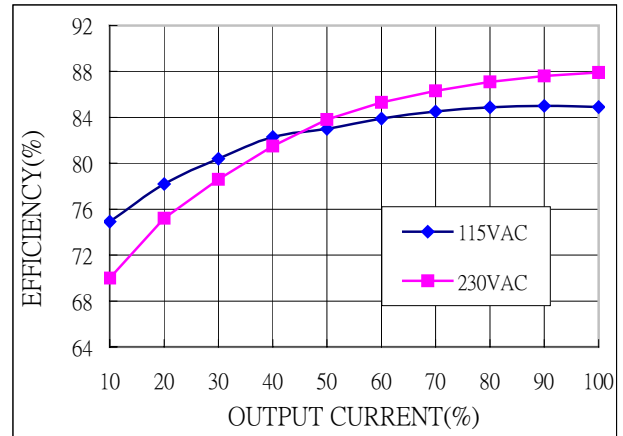

Figure 6: Efficiency vs Load (Vo=48V)

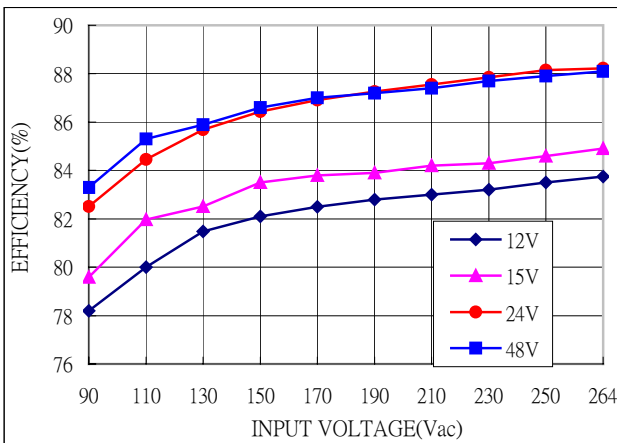

Figure 7: Efficiency vs Line at Full Load



UMEC International Corporation
 2539 West 237th Street, Suite A
 Torrance, California 90505 USA

www.umecintl.com
 Tel: 310-326-7072
 Fax: 310-326-7058

UMEC International Corporation

Performance for AD-UP1301A-12

1. Output Ripple

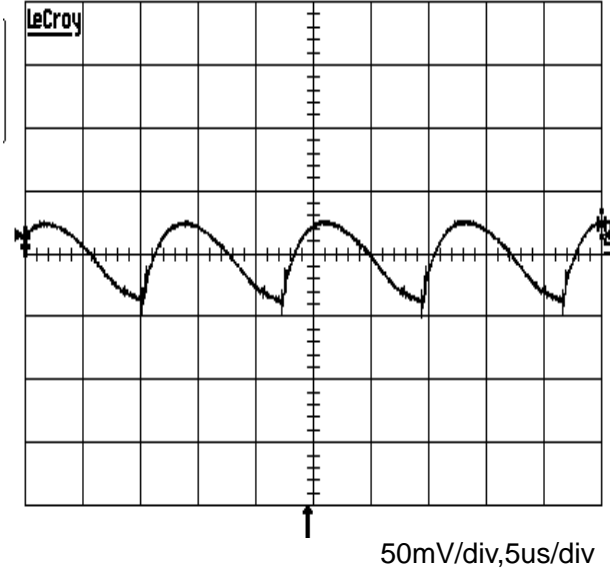

2. Output turn on wave form

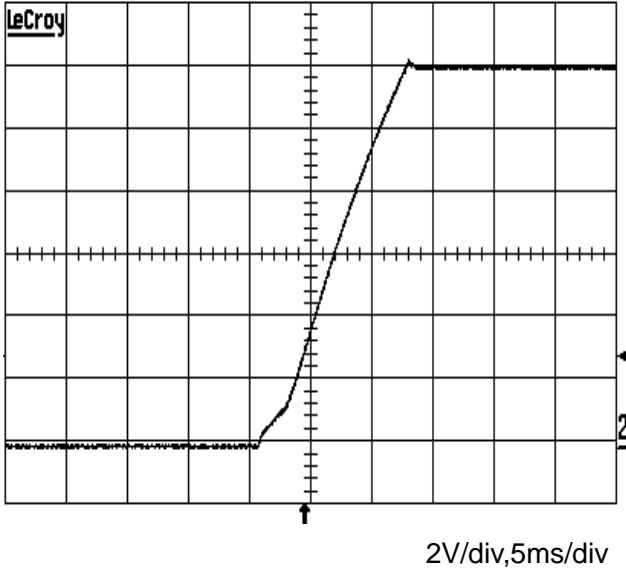

3. Hold-up time

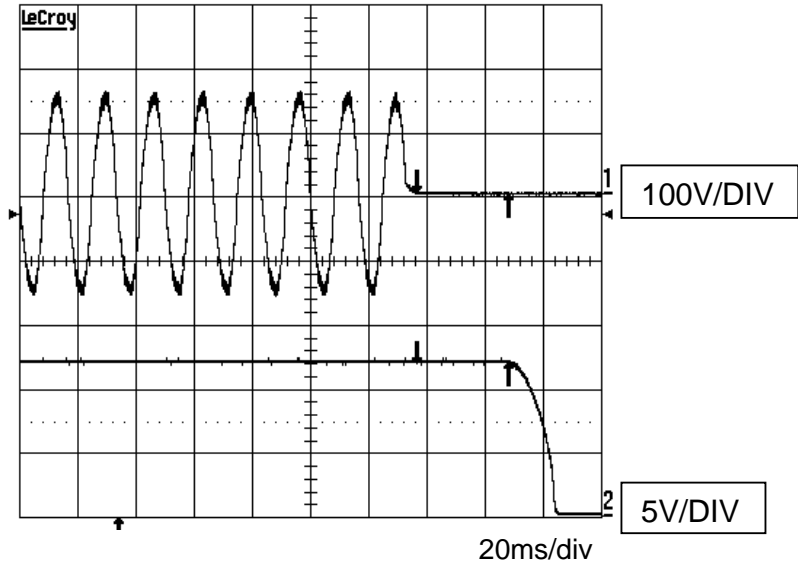

UMEC International Corporation
2539 West 237th Street, Suite A
Torrance, California 90505 USA

www.umecintl.com
Tel: 310-326-7072
Fax: 310-326-7058